



Rules of Netball

2020 Edition



INTERNATIONAL
NETBALL
FEDERATION

Not for reprint



CONTENTS

1	Introduction	5
2	Definitions	7
3	Technical Specifications	13
	3.1 Court and related areas	13
	3.2 Goalposts	17
	3.3 Ball	18
4	Match Duration	19
	4.1 Match length	19
	4.2 Extra time	19
5	Match Personnel	21
	5.1 Team	21
	5.2 Match officials	24
	5.3 Technical officials	27
6	Match Procedures	29
	6.1 Umpire procedures	29
	6.2 Team official procedures	32
7	Sanctions	33
	7.1 Types of sanctions	33
	7.2 Advantage	35
8	Controlling Play	36
	8.1 Organisation for start of play	36
	8.2 Centre pass	37
	8.3 Out of court	40
	8.4 Throw in	42
	8.5 Toss up	43
	8.6 Infringements when the ball is not in play	45
9	During the Match	46
	9.1 Substitutions and team changes	46
	9.2 Late players	46
	9.3 Stoppages	47
	9.4 Playing the ball	50

	9.5	Passing distances	52
	9.6	Footwork	53
	9.7	Offside	55
10		Scoring a Goal	56
	10.1	Requirements for scoring a goal	56
	10.2	Requirements for taking a shot	56
11		Obstruction	58
	11.1	Obstruction of a player in possession of the ball	58
	11.2	Obstruction of a player not in possession of the ball	59
12		Contact	60
	12.1	Contact and contest	60
	12.2	Interference	60
13		Game Management	62
	13.1	Actions that may be taken by umpires	62
	13.2	Foul play	66
	13.3	Discipline of team officials and bench players	68
		Explanatory Notes	
	Appendix A	Match guidelines	70
	Appendix B	Umpire hand signals	81
	Appendix C	Umpire terminology	89
	Appendix D	Variations for other levels of play	90



OFFICIAL SUPPLIER

Gilbert Netball is the official and exclusive ball supplier to INF

www.gilbert-netball.com



1. INTRODUCTION

Netball is an exciting, fast and skilful game of fair contest. It is a game in which two teams of seven players each strive to keep or gain possession of the ball.

The team with the ball, through running, jumping, throwing and catching, attempts to move the ball into its goal circle from where a goal may be scored, while the opposing team uses defensive movements and strategies to prevent this and to gain possession. The team with the greater number of goals is the winner of the match.

Players have specified areas in which they can move. Play restarts after each goal with teams having alternate possession.

The Rules are based on the core values of equal opportunity, fair play and respect for an opponent's skill and safety.

- It is the responsibility of players to ensure that they are physically and technically prepared in a manner that enables them to play the Game, comply with the Rules and participate safely in a sporting and fair manner. This includes responding to rulings made by the umpires and adjusting play accordingly.
- It is the responsibility of those who coach or teach the Game to ensure that players are prepared in a manner that ensures compliance with the Rules of the Game as well as an understanding of both sporting behaviour and safe practices.

1. INTRODUCTION

- It is the responsibility of umpires to apply the Rules of the Game with impartiality, fairness and consistency.
- It is the responsibility of controlling bodies at all levels to ensure that the Game is conducted and developed in accordance with disciplined and sporting behaviour.

While Netball developed first as a game predominantly played by women and girls, it is now played by boys and girls, women and men.

The Rules are written for international play. Variations in some Rules may be made locally for players of different levels or to meet other conditions (refer Appendix D).

INF publishes the Rules of Netball in several different languages. If there is divergence in wording, the English text is authoritative.

Copyright © 2020 International Netball Federation
All rights reserved.

No part of this publication may be reproduced, stored in a retrieval system or transmitted in any form or by any means without the prior written permission of the International Netball Federation, nor be otherwise circulated in any form of binding or cover other than that in which it is published.



2. DEFINITIONS

A

Astride the transverse line: standing with one foot in the goal third and one foot in the centre third.

At the team bench: on or immediately beside (including behind or in front of) the team bench.

Attacking team: team that has possession of the ball.

B

Bench player: a player who is on the team bench at a given time during a match.

Bench zone: area immediately outside the court surround where the official bench, team benches and umpires' bench are located (all on the same side of the court).

Breaking: early entry by a player to a third before the whistle is blown for a centre pass.

C

Caution: inform a player regarding that player's infringing and/or behaviour.

Controlling umpire: umpire in whose half play is at a given time.

Co-umpire: umpire who is not controlling play at a given time.

Court surround: area immediately surrounding the court.

D

Defending team: team not in possession of the ball.

During play: at any time during a quarter/half except when time is held.

2. DEFINITIONS

E

Event organiser: person/s with responsibility for the organisation of the match.

Extra time: an additional period of time used when the scores are tied at full-time and a winner is required.

F

Failure to take the court: A team has less than 5 players present at the start of a period of play or a team delays taking the court after a stoppage.

Fake pass: player makes passing action but does not release ball.

Field of play: area consisting of the court and the court surround.

Free pass: sanction for a minor infringement.

Full-time: end of the specified playing time for a match (60 minutes) excluding any extra time.

G

Game: the Game of Netball.

Goal end: end of the court where a team shoots for goal.

Good sportsmanship: level of behaviour that meets generally accepted ethical standards in sport, including playing by the Rules, self-discipline, self-control and respecting opponents and officials.

H

Half-time: interval between second and third quarters, in extra time the interval between the two halves.

I

INF: the International Netball Federation.



2. DEFINITIONS

Infringement: action contrary to the Rules that may be penalised by an umpire.

International play: a match between two countries played for INF ranking points.

Interval: period of time between successive periods of play.

L

Landing foot (one foot landing): foot on which a player either first lands after catching the ball or is standing on when the ball is caught.

Landing foot (two feet landing): the foot *not* first moved when a player either catches the ball standing on both feet or lands on both feet simultaneously after catching the ball.

Late Player: A player who is not ready to take the court at the start of a match or when the match is to be restarted after a stoppage or interval.

M

Major infringement: infringement of the contact or obstruction rules, when the goalpost is moved by a defending player so as to interfere with a shot at goal, when a defending player deflects a ball on its downward flight towards the ring, when a player enters the court at an incorrect time or infringement of the foul play rule.

Match: contest between two teams played according to the Rules of the Game.

Match officials: two umpires and a reserve umpire.

Minor infringement: infringement of the rules governing playing the ball, footwork, centre pass, offside and other related rules.

2. DEFINITIONS

N

Natural body stance: being stable and upright whether standing or moving, it may include slight arm movements for stability or momentum.

O

Official bench: place where the scorers and timekeepers are located during a match.

Opponent: player from the opposing team.

P

Pass: Action of a player throwing, batting or bouncing the ball to a player, dropping the ball or putting the ball on the ground and removing their hands.

Penalty pass: Sanction for a major infringement. A Goal Shooter or Goal Attack taking a penalty pass in the goal circle may either pass or shoot for goal.

Period of play: a quarter in a match or a half in extra time.

Pivot: a movement where the player with the ball swivels *either* on the heel *or* on the ball of the landing foot while this maintains contact with the ground.

Playing enclosure: area consisting of the court, the court surround and bench zone.

Playing time: time elapsed in a quarter/half not including any stoppages.

Possession: player holds the ball with one or both hands.

Primary care person: team official who is qualified to diagnose and treat injury or illness (for example doctor or physiotherapist).



2. DEFINITIONS

R

Reckless: without thinking or caring about the consequence of an action.

Reserve umpire: match official seated at the umpires' bench who is ready to replace an umpire in the event of illness/injury during a match.

Retaliation: player's inappropriate response to the action/s of another player.

S

Sanction: action taken by an umpire (free pass or penalty pass) against an infringing player, team official or bench player.

Scorers: technical officials responsible for maintaining a scoring record of the match together with a record of centre passes and details of players on court.

Set: a sanction is 'set' once the player taking the sanction is positioned correctly with the ball; in the case of a penalty pass, the infringer must also be positioned correctly.

Shot: a Goal Shooter or Goal Attack directs the ball towards the ring in an attempt to score a goal.

Simultaneous: occurs at exactly the same time.

Substitution: when a player moves from the team bench to replace a player on the court.

T

Team: up to twelve players (of whom a maximum of seven are on the court at any time) and up to five team officials.

Team bench: place where team officials and any players not on the court are located during a match.



2. DEFINITIONS

Team change: when players on court change playing positions.

Team officials: up to five persons at least one of whom is a primary care person.

Technical officials: scorers and timekeepers seated at the official bench and any other officials specified for an event.

Timekeepers: technical officials responsible for maintaining an accurate record of playing time, advising the umpires when play should end, timing intervals, stoppages and suspension period.

U

Umpires' bench: place where the umpires are seated when not on the court and the reserve umpire is seated during the match.

Measurements - the following abbreviations are used:

cm	centimetres
ft	feet
g	grams
in	inches
kPa	kilopascals
m	metres
mm	millimetres
oz	ounces
psi	pounds per square inch

3. TECHNICAL SPECIFICATIONS

3.1 COURT AND RELATED AREAS

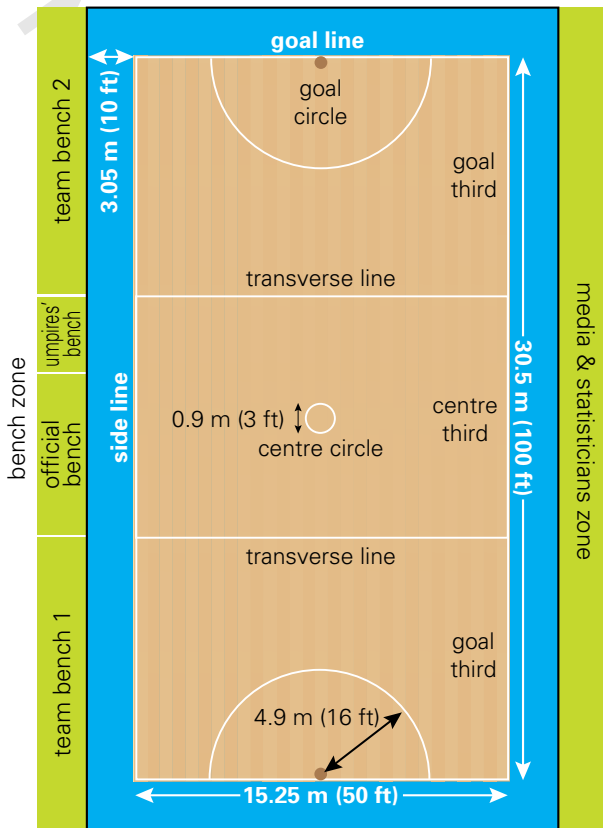

Court

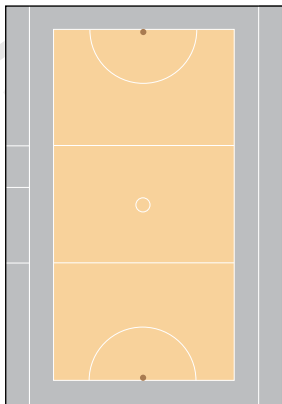

Court Surround

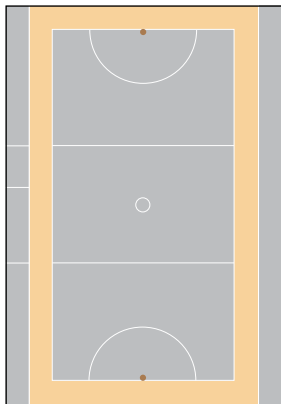

Field of Play

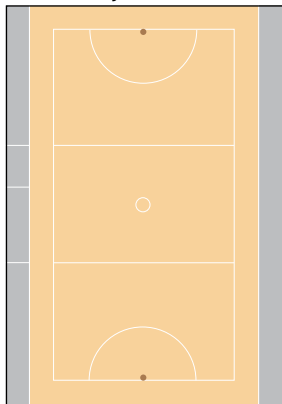

Playing Enclosure

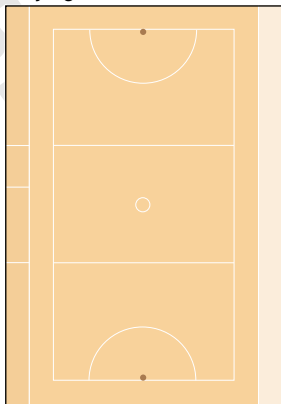



3. TECHNICAL SPECIFICATIONS

3.1.1 Court

The court is rectangular in shape and is level and firm. The surface should be wooden (preferably sprung wooden) but may consist of other material provided that it is safe to play on.

- (i) The two longer sides are called side lines and measure 30.5 m (100 ft).
- (ii) The two shorter sides are called goal lines and measure 15.25 m (50 ft).
- (iii) Two lines parallel to the goal lines divide the court into three equal areas. These lines are called transverse lines. The middle area is called the centre third and the two end areas are the goal thirds.
- (iv) A circle 0.9 m (3 ft) in diameter is located in the centre of the court. This is called the centre circle.
- (v) A goal circle is located at each end of the court. This is a semi-circle of radius 4.9 m (16 ft) whose centre is the mid-point of the outside of the goal line.
- (vi) All lines (preferably white) are 50 mm (2 in) wide and are part of the court area they outline.

3.1.2 Court Surround

The court surround is rectangular in its outer shape and it surrounds the court. The distance between the edge of the court surround and the goal lines and side lines is 3.05 m (10 ft).

3. TECHNICAL SPECIFICATIONS

3.1.3 Field of Play

The field of play is rectangular in shape and consists of the court and the court surround. During play only on-court players and umpires are permitted in the field of play.

3.1.4 Playing Enclosure

- (i) A bench zone is located immediately adjacent to the field of play. The official bench, umpires' bench and team benches are all located on one side of the court in the bench zone.
- (ii) The playing enclosure consists of the field of play and the bench zone. Entry to the playing enclosure during a match is limited to those persons with official event accreditation.
- (iii) If desired, an equivalent zone on the opposite side of the court may also be included in the playing enclosure. This zone is to be used by media and other technical officials as needed.

3. TECHNICAL SPECIFICATIONS

3.2 GOALPOSTS

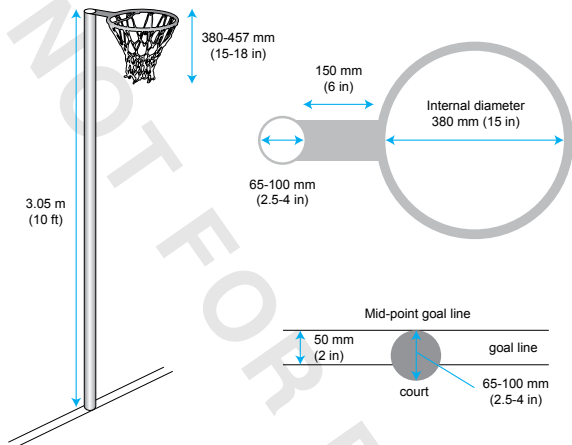

A goalpost is placed at the mid-point of each goal line. It consists of the following:

- (i) A vertical metal pole 65-100 mm (2.5-4 in) in diameter and 3.05 m (10 ft) high. The pole is:
 - (a) Inserted in the ground or sleeved beneath the floor so when it is knocked there is a minimal amount of movement and it remains stable.
 - (b) Placed so the back of the pole is at the outside edge of the goal line.
 - (c) Covered with padding of uniform thickness not more than 50 mm (2 in) thick and extending the full length of the pole.

3. TECHNICAL SPECIFICATIONS

- (ii) A horizontal metal ring made of steel rod 15 mm (5/8 in) in diameter with an internal diameter of 380 mm (15 in).
- (iii) A horizontal metal bar of length 150 mm (6 in), projecting from the front edge at the top of the pole, to which the ring is attached.
- (iv) A net (preferably white) fitted to the ring, clearly visible and open at top and bottom. The minimum length of the net is 380 mm (15 in) and maximum is 457 mm (18 in).

3.3 BALL



- (i) The match ball which is spherical in shape:
 - (a) Measures 690-710 mm (27-28 in) in circumference and weighs 400-450 g (14-16 oz).
 - (b) Is made of leather, rubber or suitable synthetic material.
 - (c) Is inflated to a pressure of 76-83 kPa (11-12 psi).
- (ii) The same match ball is used throughout a match unless the umpires instruct that it is replaced. A spare ball must be at the official bench and the umpires may order its use.
- (iii) The umpires check all match balls before play starts.

4. MATCH DURATION

4.1 MATCH LENGTH

- (i) A match consists of four quarters, each of 15 minutes playing duration, with an interval of 4 minutes between the first-second and third-fourth quarters. The half-time interval is 12 minutes (except, with the agreement of the event organiser and both teams, half-time may be 8 minutes).

1st quarter	interval	2nd quarter	half-time	3rd quarter	interval	4th quarter
15 minutes	4 minutes	15 minutes	12 (or 8) minutes	15 minutes	4 minutes	15 minutes

- (ii) Teams change ends each quarter.
- (iii) A period of play must not exceed the specified playing time, except that if a team is awarded a penalty pass in its attacking goal circle before the timekeeper signals the end of play, the umpire will blow the whistle to end the period of play and advise the players that time is being extended for the penalty pass to be taken.
- (iv) An interval may be extended by the umpires for an emergency.

4.2 EXTRA TIME

Before a match begins the event organiser may advise teams and umpires that, in the event that scores are tied at full-time, extra time will be played to determine a winner. The length of each half will also be specified. The following procedure will apply:

- (i) There is an interval of 4 minutes at the end of full-time.

4. MATCH DURATION

- (ii) Extra time consists of two halves of equal length, not exceeding 7 minutes each, with a half-time interval of 1 minute. Teams change ends at half-time.

full-time - draw	interval	1st half	half time	2nd half
winner is required	4 minutes	not exceeding 7 minutes	1 minute	not exceeding 7 minutes

- (iii) The first centre pass in each half is taken by the team entitled to the next centre pass.
- (iv) In the event of a tie remaining at the end of extra time, a visual signal is placed at the official bench to indicate that play will continue until one team leads by two goals.

end of extra time	match ends when
scores are tied	one team leads by two goals



5. MATCH PERSONNEL

5.1 TEAM

- (i) Before the start of a match, the names of all players and team officials must be provided to the scorers. Each team names one player as captain.
- (ii) During a match, a minimum of five and maximum of seven players from a team may be on the court at any one time, one of whom must play as Centre.
 - (a) If a team does not have 5 players available the umpires will award the match to the opposing team.
 - (b) If a team has more than 7 players on the court, additional players are immediately sent from the court.

Sanction: Penalty pass where the ball was when play was stopped and a player from the infringing team allowed in the playing area stands out of play.

- (c) If the additional players delay leaving the court, the umpire will penalise the infringing players for delaying play.
- (iii) Each team is allocated a team bench where team officials and bench players are located during play. Bench players may leave the team bench during play for a valid reason (such as to warm up).

5.1.1 Players

- (i) During a match players must wear:
 - (a) Registered playing uniform and suitable sports footwear (spiked soles are not allowed).
 - (b) Playing position initials 150 mm (6 in) high which must be clearly visible and worn above the waist, front and back.

5. MATCH PERSONNEL

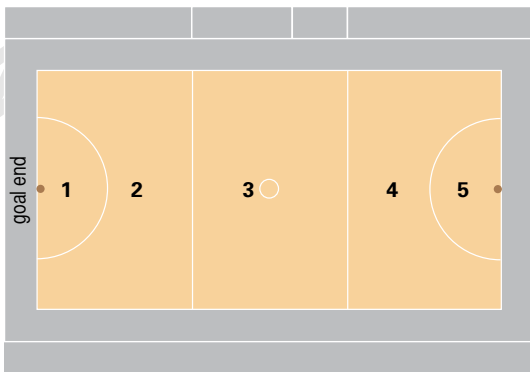

Position	Playing Areas				
Goal Shooter	1	2			
Goal Attack	1	2	3		
Wing Attack		2	3		
Centre		2	3	4	
Wing Defence			3	4	
Goal Defence			3	4	5
Goal Keeper				4	5



5. MATCH PERSONNEL

- (ii) The playing positions and initials are:
Goal Shooter (GS), Goal Attack (GA), Wing Attack (WA), Centre (C), Wing Defence (WD), Goal Defence (GD) and Goal Keeper (GK).
- (iii) All players have specified areas of the court where they are allowed to play (see diagram opposite).
- (iv) Players may not wear anything that could endanger themselves or other players, specifically:
 - (a) No adornment or jewellery may be worn other than a wedding ring which must be covered with tape.
 - (b) A medical alert bracelet may be worn provided it is covered with tape.
 - (c) Fingernails must be short and smooth.
 - (d) Hair must be suitably tied back.
- (v) Role of captain:
 - (a) Before the match starts, the two captains toss for choice of goal end or first centre pass and notify the scorers and the umpires of the result.
 - (b) The captain has the right to approach the umpires during an interval for clarification of any rule. Any player/s for whom the clarification is relevant may accompany the captain.
 - (c) The umpires may request the captain to speak to any on-court player/s whose behaviour is causing concern.
 - (d) In the event that the captain is not on the court, an on-court captain will be advised to the umpires.

5. MATCH PERSONNEL

5.1.2 Team Officials

- (i) A team may have up to five team officials. These will include a coach and at least one primary care person.
- (ii) A primary care person:
 - (a) Must be qualified to diagnose and treat injury or illness (for example, doctor or physiotherapist).
 - (b) Must wear identification as specified by the event organiser (for example an arm band).
 - (c) Must not have any other roles (including as a player).
 - (d) Is permitted on the court during a stoppage for injury/illness of a player or blood issues.
 - (e) Must advise the umpires if a player is too ill/injured to be removed from the court within 30 seconds and/or if further assistance is required.

5.2 MATCH OFFICIALS

The match officials are two umpires and a reserve umpire.

- (i) The match officials:
 - (a) Wear clothing that is distinct from the teams' playing uniforms and suitable sports footwear.
 - (b) Are responsible for ensuring the field of play (including the goalposts) and the ball conform to [Rule 3] before play starts and throughout a match.
 - (c) Before play starts, check the players off the court to ensure they meet the requirements of [Rule 5.1.1 (i) and (iv)].



5. MATCH PERSONNEL

5.2.1 Umpires

The umpires control a match according to the Rules and decide any matter not covered by them. Their decisions are final and are given without appeal.

- (i) After the captains have notified the umpires of the result of the toss for goal end or first centre pass, the umpires toss for goal end. The umpire winning the toss controls the side line nearer the official bench and the goal end to the right when facing the court. Each umpire controls the same half of the court throughout the match.
- (ii) An umpire's whistle:
 - (a) Starts and ends each quarter/half.
 - (b) Restarts play after a goal has been scored.
 - (c) Indicates when an infringement is penalised.
 - (d) May be used to indicate when the ball is out of court if clarification is needed.
 - (e) Signals when the timekeepers are to hold time and when to restart timing play.
- (iii) The umpires work co-operatively and may appeal to each other for decisions. An umpire must be ready for such an appeal at all times.
- (iv) Each umpire controls and gives decisions for one half of the court including the goal line except as provided for in (v) and (vi) below and [\[Rule 6.1.1 \(v\)\]](#). For this purpose the length of the court is divided in half across the centre from side line to side line.

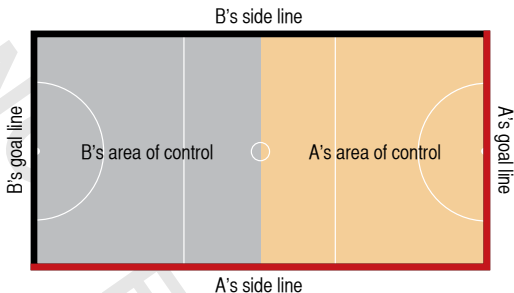

- (v) Each umpire makes all decisions for the throw in on one side line including infringements by the player taking the throw in or any opponent defending that player. If the sanction is awarded in the co-umpire's half, the co-umpire resumes control once it has been set.
- (vi) Either umpire may hold time for injury/illness of a player, blood, foul play, an emergency or other appropriate circumstances.
- (vii) For low level incidents umpires may, without holding time, give informal advice to players to change their behaviour.
- (viii) Umpires may hold time to speak to players about their behaviour.
- (ix) Umpires may hold time to request the Captain to speak to any on-court players/s whose behaviour is causing concern.

5.2.2 Reserve Umpire

The reserve umpire:

- (i) Replaces an umpire who becomes ill/injured during a match. Before



5. MATCH PERSONNEL

replacing an umpire, the reserve umpire must be aware of any cautions, warnings, suspensions or ordering off that have already been given and the reasons for the action taken by the umpires.

- (ii) May assist the umpires with any procedures prior to the match or during intervals.
- (iii) Is seated at the umpires' bench during a match.
- (iv) Supervises a suspended player during the suspension period and advises the player when the suspension period has elapsed.

5.3 TECHNICAL OFFICIALS

The technical officials are two scorers, two timekeepers and any other officials specified for the event. Only the scorers and timekeepers are seated at the official bench.

5.3.1 Scorers

The scorers are jointly responsible for keeping an accurate record of the score.

- (i) Before the start of play the scorers record the names of all players (including playing positions for the start of play) and team officials.
- (ii) During the match the scorers:
 - (a) Record any changes of players and/or positions.
 - (b) Record goals scored for each team as they occur as well as any unsuccessful shots.
 - (c) Keep a record of the centre pass taken by each team.
 - (d) Call the centre pass if appealed to by an umpire.



5. MATCH PERSONNEL

- (e) Signal the direction of any centre pass to be taken immediately after a stoppage.
- (f) Notify the umpires if a wrong centre pass is indicated [Rule 6.1.1 (iv) (b)].
- (g) Record any caution, warning, suspension and ordering off.

5.3.2 Timekeepers

The timekeepers are jointly responsible for ensuring that each period of play and each interval is of the correct length of time. The timekeepers:

- (i) Notify the umpires when there are 30 seconds and 10 seconds remaining before the start of a quarter/half.
- (ii) Commence timing when the game is started by the umpire's whistle.
- (iii) When the playing time specified for a quarter/half has elapsed, notify the umpires whose whistle ends play.
- (iv) Hold time when signalled to do so by the umpire and restart timing when the umpire signals for play to resume.
- (v) Notify the umpires when 10 seconds remain prior to the end of a stoppage for injury/illness or blood.
- (vi) Time the suspension period of 2 minutes playing time for a suspended player and advise the reserve umpire when the time has elapsed.



6. MATCH PROCEDURES

6.1 UMPIRE PROCEDURES

6.1.1 Procedures for Centre Pass

Play is started with a centre pass at the beginning of each quarter/half and after each goal scored.

- (i) The umpires notify the teams when there are 30 seconds and 10 seconds before the start of a quarter/half.
- (ii) The first centre pass in each quarter/half is started by the umpire controlling the goal end of the team taking the centre pass.
- (iii) During a quarter/half the centre pass is started by the umpire controlling the goal end where the last goal was scored.
- (iv) Immediately a goal is signalled both umpires indicate the direction of the next centre pass:
 - (a) If they disagree the umpires seek clarification from the scorer.
 - (b) In the event that both umpires indicate the centre pass direction incorrectly, the scorer notifies the umpires using an audible sound.
- (v) The umpire controlling the centre pass is responsible for penalising any infringements by the Centre taking the centre pass and any opponent defending the pass (if the sanction is awarded in the co-umpire's half, the co-umpire assumes control once it is set).

6. MATCH PROCEDURES

6.1.2 Procedures during Play

The umpires move along the side line and behind the goal line to view play and make decisions. They keep off the court during play except to take a toss up.

- (i) The umpires:
 - (a) When penalising an infringement, blow the whistle, state the infringement using the correct terminology [Appendix C], state the sanction given using the appropriate umpire hand signal [Appendix B] and indicate where the sanction is to be taken.
 - (b) When applying an advantage [Rule 7.2]: refrain from blowing the whistle for an infringement.
 - (c) Signal a goal has been scored by raising one arm vertically.
- (ii) If the ball strikes the umpire while on the court during play, or if an umpire interferes with the movements of the players, play does not cease unless one team has been unduly disadvantaged, in which case a free pass is awarded to that team.
- (iii) The umpires must not criticise or coach a team while a match is in progress.

6.1.3 Procedures for Out of Court

The umpires give decisions relating to the goal line in the half each controls and all of the nearer side line. The umpire controlling the goal line / side line is responsible for:

- (i) Ruling when the ball is out of court and the team to take the throw in (no whistle is required if it is clear the ball is out of court).



6. MATCH PROCEDURES

- (ii) Penalising infringements by the player taking the throw in or by any opponent/s defending the throw in (if a sanction is awarded in the co-umpire's half, the co-umpire resumes control once it is set).

6.1.4 Procedures for Toss Up

- (i) The umpires enter the court to take a toss up as follows:
 - (a) In the goal circle the toss up is taken by the umpire controlling that goal end.
 - (b) Outside the goal circle the toss up is taken by the nearer umpire who also controls all related procedures.
- (ii) The umpire ensures players are correctly positioned before taking a toss up.
- (iii) Before taking the toss up, the umpire momentarily is stationary, holding the ball in the palm of one hand at a point midway between the two players and just below the shoulder of the shorter player in normal standing position.
- (iv) The umpire flicks the ball vertically in the air no more than 600 mm (2 ft) and simultaneously blows the whistle.

6.1.5 Procedures for Stoppages

The umpire:

- (i) Signals to the timekeeper to hold time when required.
- (ii) Where appropriate notifies the players when 10 seconds remain prior to the end of the stoppage.
- (iii) Signals to the timekeeper when play restarts.



6. MATCH PROCEDURES

6.1.6 Procedures for Game Management

- (i) The umpire holds time to caution a player, to give a warning, to suspend a player or to order a player off, also using any umpire hand signal that applies [Appendix B].
- (ii) The controlling umpire will ensure the co-umpire is aware of the action taken and the reason for it. If necessary the umpire may hold time to inform the co-umpire of the reason for the action.
- (iii) When giving a warning, suspension or ordering off, the controlling umpire may hold time to confer with the co-umpire before deciding on the action to be taken.

6.2 TEAM OFFICIAL PROCEDURES

- (i) Team officials and bench players may coach:
 - (a) While play is in progress provided they are positioned at the team bench.
 - (b) During stoppages provided they remain either at the team bench or on the court surround and do not (except for the primary care person/s) enter the court.
 - (c) During intervals.
- (ii) Team officials and bench players must not use offensive, insulting or abusive language and/or gestures [Rule 13.3].



7. SANCTIONS

7.1 TYPES OF SANCTIONS

During a match the umpires may penalise an infringement and award a sanction to the non-infringing team as follows:

- (i) Free pass – awarded for minor infringements.
- (ii) Penalty pass – awarded for major infringements.

7.1.1 Conditions for all Sanctions

Sanctions are awarded to a team and may be taken by any player allowed in the area. The player taking the sanction must:

- (i) Take up the position indicated by the umpire as follows:
 - (a) For a free pass: the position is where the infringement occurred.
 - (b) For a penalty pass: the position is where the infringer was standing unless this disadvantages the non-infringing team.

Sanction: Free pass. If a player deliberately or repeatedly takes a sanction from the incorrect position, the player will be penalised for delaying play [Rule 13.2.1 (i)].

- (ii) Obey the footwork rule [Rule 9.6]. The foot placed at the point indicated is considered as equivalent to a 'one foot landing'.

Sanction: Free pass.

- (iii) Release the ball within 3 seconds of the sanction being set.

Sanction: Free pass.

7.1.2 Conditions for Free Pass

A player taking a free pass may not shoot for goal.

Sanction: Free pass and no goal is scored.

7. SANCTIONS

7.1.3 Conditions for Penalty Pass

- (i) The infringer must stand out of play. This means the infringer must:
 - (a) Move quickly to the position indicated.
 - (b) Stand beside but away from the player taking the penalty pass so as not to impede that player.
 - (c) Remain in this position and not move or take any part in play (including verbal comments) until the ball has been released.

Sanction: A further penalty pass is awarded (which may be advanced if it is judged to be delaying play).

- (ii) An opposing player may not obstruct or contact the player taking a penalty pass before the ball has been released.

Sanction: Penalty pass where second infringer was standing and both infringers stand out of play.

- (iii) If Goal Shooter or Goal Attack takes a penalty pass in the goal circle, the player may either pass or shoot for goal. If this has been awarded but has not been taken when the timekeeper signals the end of a period of play, the umpire will blow the whistle to end the period of play and advise the players that time is being extended for the penalty pass to be taken.
- (iv) A player who is correctly positioned to take a penalty pass may choose to play the ball before the sanction has been set. If the player chooses to play the ball immediately, the infringer may not take part in play until the ball has been released or make any attempt to intercept the penalty pass.

Sanction: A further penalty pass is awarded (which may be advanced if it is judged to be delaying play).



7. SANCTIONS

- (v) If an infringer is substituted or changes positions before a penalty pass is taken, the player who takes the position of the penalised player stands out of play.
- (vi) If a player is suspended or ordered off, a penalty pass is awarded to the non-infringing team and no player from the infringing team is required to stand out of play for the penalty pass.

7.2 ADVANTAGE

A team should not be disadvantaged when an opponent infringes. In particular, the umpire should refrain from blowing the whistle for an infringement when by so doing the non-infringing team would be disadvantaged.

- (i) The umpire indicates an advantage is being applied by:
 - (a) Calling 'advantage' and stating the infringement.
 - (b) Using the umpire hand signal for advantage [Appendix B].
- (ii) If the whistle is blown for an infringement the sanction must be awarded, except that if a goal is scored that is to the advantage of the non-infringing team, the umpire will award the goal.



8. CONTROLLING PLAY

8.1 ORGANISATION FOR START OF PLAY

- (i) For each quarter/half:
 - (a) When the umpires indicate there are 10 seconds before the start of play, players must take the court.
 - (b) Players must be positioned in the correct thirds when play is due to start.
- (ii) A team must take the court if there are at least five players present, one of whom must play as Centre.

8.1.1 Failure to Take the Court

- (i) If a team does not have five players present at the start of a quarter/half, the umpires will wait up to 30 seconds for additional player/s to arrive:
 - (a) If the team takes the court within 30 seconds: the offending team will be penalised immediately following the whistle for the centre pass.
Sanction: Penalty pass taken in centre third by the transverse line at the goal end of the non-infringing team. The whistle is blown to start play then the infringement is penalised. The Centre stands out of play for the penalty pass.
 - (b) If the team is not able to take the court within 30 seconds: the umpires will award the match to the opposing team.
- (ii) If a team delays taking the court after a stoppage when requested by the umpires, the umpires penalise the team for delaying play as soon as play resumes. If play was due to restart with a centre pass, the sanction is awarded immediately following the whistle for the centre pass.



8. CONTROLLING PLAY

Sanction: Penalty pass which is advanced (unless the non-infringing team is disadvantaged). The whistle is blown to start play then the infringement is penalised. The captain is cautioned and the Centre stands out of play for the penalty pass.

- 1. The sanction may be advanced up to half a third (this may be to inside the goal circle if play was due to restart in the goal third).*
- 2. The Centre stands out of play at the new position. If this is in the goal circle the Centre moves to the edge of this area.*

8.2 CENTRE PASS

- (i) Play is started at the beginning of each quarter/half and after each goal by a centre pass. The centre pass is taken alternately by the Centre of each team.
- (ii) At a centre pass, before the whistle was blown to end the quarter/half, the centre pass will be ruled **not** to have been taken if:
 - (a) The ball is still in the Centre's hands and no player from that team has been penalised.
 - (b) The ball is knocked out of the Centre's hands by a player from the opposing team.
 - (c) An intentional infringement by the opposing team has been penalised and the penalty pass has not been taken.

8.2.1 Positioning of Players for Centre Pass

- (i) The Centre in possession of the ball stands with at least one foot wholly within the centre circle.

Sanction: Free pass in centre circle. The whistle is blown for the centre pass then the infringement is penalised.



8. CONTROLLING PLAY

(ii) The opposing Centre is in the centre third and free to move.
Sanction: Free pass in the goal third by the transverse line where the opposing Centre was in contact with the ground in the goal third. The whistle is blown for the centre pass then the infringement is penalised.

(iii) All other players are in their respective goal thirds and are free to move but must not enter the centre third until the whistle has been blown to start play.

Sanction: Free pass in the centre third near the transverse line where the player entered the centre third. The whistle is blown for the centre pass then the infringement is penalised.

(iv) If two opposing players enter the centre third simultaneously before the whistle is blown:

- (a) If neither player makes contact with the ball they are not penalised and play continues.
- (b) If either player catches or touches the ball, either while standing in the centre third or immediately before or after landing in the centre third, a toss up is taken between the two players concerned where the player caught or touched the ball.
- (c) If one umpire blows the whistle for a sanction and the other umpire indicates an advantage has applied, the sanction will stand.

8.2.2 Controlling the Centre Pass

- (i) When the whistle is blown to start play, the Centre in possession of the ball may step outside the centre circle but must obey the footwork rule [Rule 9.6]. If when the whistle was blown:
 - (a) Only one foot was wholly inside the centre circle, this foot will be considered the 'landing foot'.



8. CONTROLLING PLAY

(b) Both feet were wholly inside the centre circle, the foot not moved first will be considered the 'landing foot'.

(ii) The Centre must release the ball within 3 seconds.

Sanction for (i), (ii): Free pass.

(iii) A centre pass must be touched or caught by a player who:

(a) Is standing wholly within the centre third.

or

(b) Lands with the first or both feet wholly within the centre third.

Sanction: Free pass in the goal third by the transverse line where the player was in contact with the ground in the goal third.

(iv) The ball from a centre pass may not go untouched over the side line bounding the centre third.

Action: Throw in by the opposing team near where the ball crossed the side line.

(v) A player from the team taking the centre pass may not:

(a) Touch or catch the ball in the air then land on both feet simultaneously astride the transverse line.

or

(b) Touch or catch the ball in the goal third if it has not been touched as in [Rule 8.2.2 (iii)].

Sanction: Free pass in the goal third by the transverse line where the player was in contact with the ground in the goal third.

(vi) The umpire may apply advantage [Rule 7.2] and allow play to continue if a player from the opposing team:

(a) Catches the centre pass in the goal third.

or

8. CONTROLLING PLAY

- (b) After catching the ball in the air lands with feet astride the transverse line (this player's subsequent pass is deemed to have been made from the goal third).

8.3 OUT OF COURT

8.3.1 Ball Out of Court

- (i) The ball is out of court when:
 - (a) It touches the ground outside the court.
 - (b) It touches any person or object in contact with the ground outside the court.
 - (c) A player on court is holding the ball which is in contact with the ground, an object or a person outside the court.

Action: Throw in by the team that did not touch the ball last on court to be taken in line with where the ball is out of court.

- (ii) The ball is put out of court by a player who:
 - (a) Catches the ball in the air just before landing with the ball either wholly or partly outside the court.
 - (b) Catches or touches the ball while standing on the ground, partly inside and partly outside the court.

Action: Throw in by the team that did not catch or touch the ball to be taken in line with where the player landed or is standing outside the court.

- (iii) If the ball is caught simultaneously by two opposing players, either of whom lands or is standing wholly or partly outside the court, a toss up is taken on court between the players concerned.
- (iv) A ball is not out of court if it hits any part of the goalpost and rebounds into the court.



8. CONTROLLING PLAY

8.3.2 Player Outside the Court

- (i) A player may jump from a position inside the court and throw or bat the ball before landing outside the court.
- (ii) A player having no contact with the ball may move into the court surround provided this is done solely for the purpose of repositioning back onto the court.

Sanction: Free pass on court near where the player left the court.

- (iii) A player who has left the court to retrieve a ball or to take a throw in must be allowed direct re-entry to the court.

Sanction: Penalty pass on court near where the player left the court.

- (iv) A player who is partly or wholly in the court surround must re-enter the court and have no contact with the court surround before playing the ball.

Action: Throw in by the opposing team in line with where the player last had contact with the court surround before playing the ball.

- (v) A player who leaves the field of play without the permission of the umpire may not be replaced. If this player is the Centre, one player must immediately move to play as Centre. The player may, after first reporting to the umpire, return to the court immediately after:
 - (a) A goal has been scored (in this case the player must play in the vacant position).
 - (b) A stoppage for injury/illness.
 - or
 - (c) An interval.

Sanction: The player is sent from the court until the correct time for entry. Penalty pass to the opposing team where the ball was when play was



8. CONTROLLING PLAY

stopped and an infringing team player allowed in the playing area stands out of play for the penalty.

8.3.3 Defending a Player from Out of Court

A player who is standing outside the court may not attempt to defend a player on the court whether that player has the ball or not.

Sanction: Penalty pass taken on the court close to where the infringer was standing.

8.3.4 Defending a Player who is Out of Court

- (i) A player may defend an opponent who has chosen to go out of court provided the defending player does not leave the court or infringe any other rule.

Sanction: Penalty pass taken on the court where the infringer was standing.

- (ii) A player who goes out of court to retrieve a ball or to take a throw in must be allowed back on the court at the point where the player left the court or took the throw in. Any opponent attempting to prevent the player from re-entering the court is penalised:

Sanction: Penalty pass taken on the court where the infringer was standing.

8.4 THROW IN

When the ball is ruled to be out of court play restarts with a throw in.

8.4.1 Requirements for Taking Throw In

- (i) The player taking the throw in:
- (a) Stands outside the court with at least one foot within 15 cm (6 in) of the line at the point indicated by the umpire (this foot is considered 'the landing foot').



8. CONTROLLING PLAY

- (b) Ensures all other players are on the court before releasing the ball.
- (c) Throws the ball within 3 seconds of taking up this position.
- (d) Observes the rules for playing the ball, passing distances and footwork [Rules 9.4-9.6].
- (e) May not enter the court (including the lines bounding the court) until the ball has been released.
- (f) May not step behind any offside area while holding the ball.

Action: Throw in to the opposing team where the infringement took place.

- (ii) The player taking the throw in must throw the ball:
 - (a) From the goal line: into the goal third.
 - (b) From the side line: into the nearest or adjacent third.

Sanction: Free pass taken in the third where ball entered incorrectly.

- (iii) The ball from a throw in must not go out of court without being touched.

Action: Throw in to the opposing team where the ball went out of court.

- (iv) The ball from a throw in must enter the court.

Action: Throw in to the opposing team from the same position.

8.5 TOSS UP

A toss up is taken to restart play when:

- (i) Two opposing players gain possession of the ball simultaneously with one or both hands.
- (ii) Two opposing players send the ball out of court simultaneously or the umpire is unable to determine which player touched it last.
- (iii) Two opposing players are offside simultaneously and one or both touch or catch the ball [Rule 9.7.1 (ii) (b)].

8. CONTROLLING PLAY

- (iv) At a centre pass, two opposing players enter the centre third before the whistle and one or both touch or catch the ball.
- (v) Two opposing players contact each other simultaneously.
- (vi) After a stoppage, the umpires are unable to determine which player had the ball or the ball was on the ground when play stopped.

8.5.1 Position for Toss Up

The toss up is taken between the two opposing players concerned at the point where the incident occurred, except when it involves players who have different playing areas as follows:

- (i) If the two players have a common playing area: the toss up is taken between them in their common area as close as possible to the original position.
- (ii) If the two players have no common playing area: the toss up is taken in the centre third between any two opposing players allowed in the area at a point as close as possible to the original position.

8.5.2 Position of Players for Toss Up

- (i) Before taking the toss up the umpire checks the two players are positioned as follows:
 - (a) The players face each other and their goal ends.
 - (b) There is a distance of 0.9 m (3 ft) between the nearest part of the nearer feet of the players.
 - (c) Their arms are straight with hands at sides.
- (ii) The two players remain stationary until the whistle is blown as the umpire releases the ball.



8. CONTROLLING PLAY

Sanction: Free pass where the infringer was standing.

- (iii) All other players may stand or move anywhere within their playing areas provided they do not interfere with the toss up.

Sanction: Free pass where the infringer was standing.

8.5.3 Outcome of Toss Up

- (i) Either player may catch the ball or bat it in any direction except directly at another player.

Sanction: Free Pass.

- (ii) A Goal Shooter or Goal Attack who catches the ball at a toss up in the goal circle may either shoot for goal or pass.

8.6 INFRINGEMENTS WHEN THE BALL IS NOT IN PLAY

A player must not infringe when the ball is not in play. This includes:

- (i) Between the ball going out of court and a throw in being taken.
- (ii) Between the awarding and the taking of a sanction or a toss up.
- (iii) Between the scoring of a goal and the taking of a centre pass.
- (iv) During a stoppage.

Sanction: Free pass (for minor infringement) or penalty pass (for major infringement). If the action is considered appropriate, the player is cautioned.

1. *For (i) and (ii) the infringement is penalised immediately.*
2. *For (iii) and (iv) the whistle is blown to start play then the infringement is penalised.*



9. DURING THE MATCH

9.1 SUBSTITUTIONS AND TEAM CHANGES

- (i) Both teams have the right to make substitutions and/or team changes:
 - (a) During an interval.
 - (b) When play is stopped for injury/illness or blood.
- (ii) The number of substitutions is not limited provided the players used are those named for the match.

9.2 LATE PLAYERS

- (i) A player who arrives after the start of a match must be checked by an umpire before taking the court to ensure they meet the requirements of [Rule 5.1.1 (i) and (iv)].
- (ii) A late player may not immediately replace a player who is already on the court but may be used subsequently as a substitute.
- (iii) If the position has been left vacant the late player may, after advising the umpire, take the court immediately after:
 - (a) A goal has been scored (in this case the late player must play in the position left vacant).
 - (b) A stoppage for injury/illness or blood.
 - (c) An interval.
- (iv) If the position has been left vacant the late player may not enter the match while play is in progress.

Sanction for (i), (ii), (iii), (iv): The player is sent from the court until the correct time for entry. Penalty pass to the opposing team where the ball was when play was stopped and an infringing team player allowed in the playing area stands out of play for the penalty.

9. DURING THE MATCH

9.3 STOPPAGES

- (i) The umpires hold time for injury/illness upon appeal from an on-court player or for blood and may hold time for an emergency or such other circumstances as they consider appropriate. During a stoppage:
 - (a) For injury/illness of a player or blood: all players not affected or being substituted remain on the court.
Sanction: Free pass on court near where the player left the court. If multiple players left the court the umpire will decide where the free pass is to be taken.
 - (b) In an emergency or other circumstances: the umpires decide whether the players leave the court or not.
- (ii) Play restarts from where the ball was when play stopped:
 - (a) If the ball was out of court play restarts with a throw in.
 - (b) If an infringement was signalled before play was held play restarts with the sanction awarded.
 - (c) If the ball was on the ground or the umpire is unable to say which team had possession of the ball, play restarts with a toss up between any two opposing players allowed in the area.
 - (d) If a player was in possession of the ball when time was held by the umpire, any player from that team allowed in the area may have possession of the ball for the restart of play.
- (iii) In extreme circumstances and in consultation with the event organiser, the umpires may decide to abandon a match if the safety of players and/or officials is considered to be at risk.



9. DURING THE MATCH

9.3.1 Injury/Illness or Blood

- (i) The umpires hold time for blood when noticed or for injury/illness when requested by an on-court player (in extreme circumstances the umpires may hold time without a request being made).
- (ii) The player concerned must leave the court within 30 seconds and receive any treatment off the court. The timekeepers advise the umpires when 10 seconds remain.
- (iii) Only primary care person/s are permitted on the court to assess the player's medical condition and to assist the player from the court.
- (iv) In the event that the primary care person/s advise the umpires that the player concerned cannot be removed safely within 30 seconds, the umpires will extend the time for the player to leave the court.
- (v) The umpires may authorise other persons (including team officials) to assist the player to leave the court if needed.
- (vi) Any blood on the ball or the court must be cleaned before play restarts and any blood-stained clothing replaced.
- (vii) Any other players with blood on them and/or their clothing must leave the court and have the blood stained clothing replaced and blood cleaned off their body, before play restarts.
- (viii) During the stoppage both teams may make substitutions and/or team changes, provided these are completed within the time allowed for the stoppage by the umpires.
- (ix) If no substitution is made for the injured/ill player, or for a player who is bleeding, play may resume with the position left vacant. If the player is the Centre and no substitution is made, one player must move to play as Centre to allow the match to continue.



9. DURING THE MATCH

- (x) If the position has been left vacant the player concerned or a substitute may not enter the match while play is in progress.
Sanction: The player is sent from the court until the correct time for entry. Penalty pass where ball was when play was stopped and a player from the infringing team allowed in the area stands out of play for the penalty.
- (xi) If the position has been left vacant the player concerned or a substitute may subsequently, after advising the umpire, take the court immediately after one of the following:
- (a) A goal has been scored (in this case the player or a substitute must play in the position left vacant).
 - (b) A stoppage for injury/illness or blood.
 - (c) An interval.

9.3.2 Other Stoppages:

- (i) The umpires may hold time or extend an interval if considered appropriate. Examples for which time may be held include (but are not limited to):
 - (a) Emergencies such as serious injury/illness of a player, injury/illness of an umpire or technical official/s, the equipment, the court, the weather or technical equipment.
 - (b) Retrieving the ball if it leaves the field of play.
 - (c) Disciplining a player, team official or bench player.
- (ii) The umpires decide the length of such a stoppage and ensure play restarts as soon as possible.
- (iii) Team officials are not permitted on the court during a stoppage other than specified in [Rule 9.3.1 (iii) and (v)].



9. DURING THE MATCH

9.4 PLAYING THE BALL

9.4.1 Methods of Playing the Ball

- (i) To gain possession a player may:
 - (a) Catch the ball with one or both hands.
 - (b) Roll the ball to oneself.
 - (c) Catch the ball if it rebounds from the goalpost.
- (ii) A player who has possession of the ball may throw or bounce it in any direction to another player with one or both hands.
- (iii) The player with the ball must release the ball within 3 seconds.

Sanction: Free pass where the player was standing.

- (iv) After releasing the ball, a player may not replay the ball until it has been touched by another player or it rebounds from the goalpost.

Sanction: Free pass where the player was standing when the ball was replayed.

- (v) Without having possession of the ball a player may:
 - (a) Bat or bounce the ball to another player but may not bat it deliberately at another player.
 - (b) Tip the ball in an uncontrolled manner once or more than once, then either catch the ball or bat or bounce it to another player.
 - (c) Bat the ball once before either catching the ball or batting or bouncing it to another player.
 - (d) Bounce the ball once before either catching the ball or batting or bouncing it to another player.

Sanction: Free pass.



9. DURING THE MATCH

(vi) A player may not:

- (a) Kick the ball.
- (b) Fall on the ball to gain possession.
- (c) Strike the ball with a fist.
- (d) Roll the ball to another player.

Sanction: Free pass.

(vii) A player who falls to the ground while holding the ball must regain footing before playing the ball and release it within 3 seconds of first catching it.

Sanction: Free pass.

(viii) A player may not:

- (a) Gain possession of the ball while lying, sitting or kneeling on the ground.
- (b) Throw or play the ball while lying, sitting or kneeling on the ground.

Sanction: Free pass.

(ix) A player may not use the goalpost to regain balance or as a support to recover the ball.

Sanction: Free pass.



9. DURING THE MATCH

9.5 PASSING DISTANCES

9.5.1 Short Pass

- (i) When a player passes the ball there must be sufficient space for an opposing player on the court to be able to intercept the ball with a hand as it moves from the hands of the thrower to those of the receiver.

Sanction: Free pass where the thrower was standing.

- (ii) If two players from the same team gain possession of the ball in quick succession, the second player's hands must be removed or it will be deemed to be a short pass.

Sanction: Free pass.

- (iii) If two opposing players gain possession of the ball in quick succession, the umpire calls 'possession', indicates the player who caught the ball first and allows play to continue.

9.5.2 Over a Third

The ball must be caught or touched by a player in each third of the court.

- (i) The player who touches or catches the ball must:
- (a) Be standing wholly in the third concerned when the ball is caught or touched.
 - or
 - (b) After catching or touching the ball in the air, land either with the first foot or both feet wholly in the third concerned.

Sanction: Free pass taken by the transverse line where the ball first entered the third incorrectly, except if the ball goes out of court over the goal line a throw in is awarded.



9. DURING THE MATCH

- (ii) After catching the ball correctly a player may step into an adjacent third. Any subsequent throw is deemed to have been made from the third where the player first landed.
- (iii) If a player either catches the ball before landing with feet astride the transverse line, or is standing on both feet astride the transverse line when the ball is caught, the pass made by this player must be touched or caught in one of these two thirds.

Sanction: Free pass taken in the goal third by the transverse line where the ball entered the third incorrectly.

9.6 FOOTWORK

9.6.1 One Foot Landing

A player who either receives the ball with one foot on the ground or, who after catching the ball in the air lands on one foot, may:

- (i) Step with the second foot in any direction, lift the landing foot and throw or shoot before the landing foot is regrounded.
- (ii) While pivoting on the landing foot, step with the second foot in any direction one or more times. The landing foot may be lifted but the player must throw or shoot before regrounding it.
- (iii) Jump from the landing foot onto the second foot and jump again but must throw the ball or shoot before regrounding either foot.
- (iv) Step with the second foot and jump but must throw the ball or shoot before regrounding either foot.

Sanction for (i), (ii), (iii), (iv): Free pass.



9. DURING THE MATCH

9.6.2 Two Feet Landing

A player who receives the ball while both feet are on the ground, or who catches the ball in the air and lands on both feet simultaneously, may:

- (i) Step with one foot in any direction, lift the second foot and throw or shoot before the second foot is regrounded.
- (ii) Step with one foot in any direction one or more times while pivoting on the second foot. The second foot may be lifted but the player must throw or shoot before regrounding it.
- (iii) Jump from both feet onto one foot but must throw or shoot before regrounding the second foot.
- (iv) Step with one foot then jump but must throw the ball or shoot before regrounding either foot.

Sanction for (i), (ii), (iii), (iv): *Free pass.*

9.6.3 Other Foot Movements

A player in possession of the ball may not:

- (i) Drag or slide the landing foot.
- (ii) Hop on either foot.
- (iii) Jump from both feet and land on both feet while still in possession of the ball.

Sanction for (i), (ii), (iii): *Free pass.*



9. DURING THE MATCH

9.7 OFFSIDE

- (i) A player is offside when the player enters a court area not designated for that player's position. This applies whether the player has contact with the ball or not.

Sanction: Free pass.

- (ii) A player may reach across and pick up a ball from an offside area or lean on the ball in an offside area, provided the player makes no physical contact with the ground in that area.

Sanction: Free pass where the player made physical contact with the ground in an offside area.

9.7.1 Opposing Players Offside

- (i) If two opposing players enter an offside area, one before the other, the first player is penalised.

Sanction: Free pass.

- (ii) If two opposing players enter an offside area simultaneously:
 - (a) If neither player makes any contact with the ball they are not penalised and play continues.
 - (b) If either player catches or touches the ball while standing in the offside area, or immediately before or after landing in the offside area, a toss up is taken between the two players in their own area of play.



10. SCORING A GOAL

10.1 REQUIREMENTS FOR SCORING A GOAL

A goal is scored when the ball is thrown or batted above and completely through the ring by Goal Shooter or Goal Attack from any point within the goal circle including the lines bounding the goal circle.

- (i) If the whistle to end play or to hold time is blown before the ball has passed completely through the ring no goal is scored.
- (ii) If a player other than Goal Shooter or Goal Attack throws or bats the ball through the ring no goal is scored and play continues.
- (iii) If a defending player deflects a shot for goal and the ball then passes above and completely through the ring a goal is scored.
- (iv) If the ball is won at a toss up in the goal circle the Goal Shooter or Goal Attack may either shoot for goal or pass.

10.2 REQUIREMENTS FOR TAKING A SHOT

- (i) In taking a shot at goal the player must:
 - (a) Have no contact with the ground outside the goal circle either while catching or holding the ball. The player may lean on the ball in the goal third outside the goal circle or may roll the ball or pick it up from this area, provided the player makes no physical contact with the ground outside the goal circle.

Sanction: Free pass where the player made physical contact with the ground outside the goal circle.

- (b) Shoot within 3 seconds of catching the ball.
- (c) Obey the footwork rule [Rule 9.6].

Sanction for (b), (c): Free pass.



10. SCORING A GOAL

- (ii) A defending player may not:
 - (a) Cause the goalpost to move so as to interfere with a shot at goal.
 - (b) Deflect a ball on its downward flight towards the ring, including touching the ball up through the net.

Sanction: Penalty pass. If a shot is successful the goal is scored.

11. OBSTRUCTION

Sanction for obstruction infringements: *Penalty pass where the infringer was standing unless this places the non-infringing team at a disadvantage.*

11.1 OBSTRUCTION OF A PLAYER IN POSSESSION OF THE BALL

An opposing player may attempt to deflect or intercept the ball or defend a player in possession of the ball, provided there is a distance of not less than 0.9 m (3 ft) measured on the ground from the nearest part of the landing foot of the player with the ball to the nearest part of the opposing player's nearer foot.

This distance is measured on the ground as follows:

- (i) One foot landing by the player with the ball:
 - (a) If the player remains in the landing position: from the nearest part of the landing foot to the nearest part of the nearer foot of the opposing player.
 - (b) If the player lifts the landing foot: from the point where the nearest part of the landing foot was grounded to the nearest part of the nearer foot of the opposing player.
- (ii) Two feet landing by the player with the ball:
 - (a) If the player does not move either foot: from the nearest part of the foot that is closer to the nearest part of the nearer foot of the opposing player.
 - (b) If the player moves one foot: from the nearest part of the foot that remains grounded to the nearest part of the nearer foot of the opposing player.
- (iii) If the player with the ball pivots on the landing foot, the nearest part of the landing foot may change and the opposing player must adjust so that the nearest part of their nearer foot is not less than 0.9 m (3 ft) from the nearest part of where the landing foot is now grounded.



11. OBSTRUCTION

- (iv) An opposing player who is the correct distance from a player with the ball may attempt to intercept the ball or defend the player with the ball:
 - (a) Either by jumping upwards or towards the player with the ball and landing within 0.9 m (3 ft) provided this does not interfere with the shooting or passing action.
 - (b) If the player with the ball reduces the distance between them.
- (v) A defending player may be within 0.9 m (3 ft) of an opponent with the ball provided there is no interference with the throwing or shooting action of this player. The defending player may not make any effort to deflect or intercept the ball or defend the player with the ball.

11.2 OBSTRUCTION OF A PLAYER NOT IN POSSESSION OF THE BALL

- (i) A player who is within 0.9 m (3 ft) of an opponent (measured between the nearest part of the nearer feet on the ground) may stretch out arms to:
 - (a) Catch, deflect or intercept a pass or a fake pass.
 - (b) Catch, deflect or bat a rebound from an unsuccessful shot at goal.
 - (c) Momentarily signal for a pass or to indicate the intended direction of a movement.
- (ii) A player who is within 0.9 m (3 ft) of an opponent (measured between the nearest part of the nearer feet on the ground) may not, whether attacking or defending, use movements that take the arms away from the body so as to limit the possible movement of an opponent, except as required for natural body stance.

12. CONTACT

Sanction for contact infringements: *Penalty pass where the infringer was standing unless the places the non-infringing team at a disadvantage.*

12.1 CONTACT AND CONTEST

When attacking, defending or playing the ball, opposing players may come into physical contact with each other. Provided the players do not interfere with each other's play or use their bodies to gain an unfair advantage over their opponent, it is deemed to be 'contest' and play continues. 'Contact' occurs when a player's actions interfere with an opponent's play whether these are accidental or deliberate.

12.2 INTERFERENCE

Interference may occur in the following ways:

- (i) Physical contact using any part of the body to limit an opponent's ability to move freely (this includes, but is not limited to, pushing, tripping, holding or leaning on an opponent).
- (ii) Knocking or hitting a player including when shooting for goal.
- (iii) Placing hand/s on the ball held by an opponent.
- (iv) Hitting the ball held by an opponent or removing it from an opponent's possession.
- (v) While holding the ball, pushing it into an opponent.



12. CONTACT

12.2.1 Moving into Player's Space

A player causes contact by:

- (i) Landing in a place already occupied by an opponent before the movement began.
- (ii) Moving into the path of an opponent who is committed to a particular landing space.

12.2.2 Inevitable Contact

Player/s, whether moving or stationary, may not position so closely to an opponent that this player is unable to move without contacting.

12.2.3 Simultaneous Contact

If two opposing players contact simultaneously a toss up is taken between the two players concerned.



13. GAME MANAGEMENT

The umpires apply the Rules of the Game fairly, communicate clearly and maintain a calm, decisive control.

A player who infringes any part of the foul play rule [Rule 13.2] will be disciplined. Players on the court are expected to respond to rulings by the umpires and adjust their play accordingly.

Similar requirements apply to team officials and bench players.

13.1 ACTIONS THAT MAY BE TAKEN BY UMPIRES

- (i) To manage a match the umpires may, *in addition to the normal sanction*, use any of the following actions:
 - (a) Caution a player: a player is advised that the behaviour specified must change.
 - (b) Issue a warning to a player: a player is warned that suspension will follow if the player continues to infringe the foul play rule.
 - (c) Suspend a player: a player who is suspended takes no part in play for 2 minutes playing time.
 - (d) Order a player off: a player who is ordered off takes no further part in the match.
- (ii) Normally an umpire will work through these actions in the order indicated unless an offence is serious enough to require a higher level of Game Management to be applied immediately.
- (iii) A decision to give a caution, a warning, to suspend a player or order a player off will be considered to have been made jointly by both umpires and is binding on the co-umpire.



13. GAME MANAGEMENT

- (iv) To give a caution, warning, suspension or ordering off, the umpire will:
 - (a) Hold time.
 - (b) Signal to the official bench, using the appropriate umpire hand signal [Appendix B].
 - (c) Use the specific term 'caution', 'warning', suspension' or 'ordering off'.
 - (d) Advise the player of the behaviour for which the action is being applied.
 - (e) State any action that will follow if the behaviour does not change.
- (v) The co-umpire may hold time if an act of foul play is observed that is not seen by the controlling umpire and a sanction has not already been awarded for an infringement. Such cases should be limited to serious actions which require a warning, suspension or ordering off.
 - (a) The co-umpire will immediately blow the whistle to hold time and provide details of the foul play to the controlling umpire with a recommendation of the action that should be taken.
 - (b) The controlling umpire will make the final decision about any action to be taken and will restart play.

13.1.1 Caution

An umpire may give a caution to a player and advise that a specified behaviour must change.

- (i) Only one caution may be given to a player for a specific instance of foul play.
- (ii) If a player is given a caution for different instances of foul play, the umpire must consider escalating this to a warning.

13. GAME MANAGEMENT

13.1.2 Warning

If a player continues to infringe after receiving a caution for a specified behaviour, the umpire will issue a warning to the player.

- (i) Where appropriate a warning may be given even if no caution has been issued.
- (ii) Only one warning may be given to a player in a match.

13.1.3 Suspension

The umpire will suspend a player following a warning if the player continues to infringe the foul play rules.

- (i) Where appropriate the umpire may suspend a player even if no warning has been given.
- (ii) Only one suspension may be given to a player in a match.
- (iii) A player who is suspended must immediately leave the court.
- (iv) While off the court the suspended player is seated at the umpires' bench under the supervision of the reserve umpire.
- (v) No substitute is permitted and the suspended player's position is left vacant unless this player is the Centre. In this case one player must move to play as Centre during the suspension.
- (vi) The suspension period of 2 minutes playing time begins when play recommences. Once the suspension period has been completed, the suspended player is able to return to the court at the next break in play (after a goal is scored, during a stoppage or interval, when a sanction is awarded, a throw in or toss up taken).



13. GAME MANAGEMENT

- (vii) The suspended player returns to the original playing position and any player who moved to play as Centre during the suspension returns to the previous playing position.
- (viii) A suspended player may join the team during any interval that occurs during the suspension but must return to the umpires' bench when play resumes.

13.1.4 Ordering off

The umpire will order a player off the court following a suspension if the player continues to infringe the foul play rules.

- (i) Where appropriate an umpire may order a player off the court even if no suspension has been given.
- (ii) A player who has been ordered off may not take any further part in the match.
- (iii) A player who is ordered off must immediately leave the court.
- (iv) The player reports to the appropriate team officials on the team bench and may not re-enter the field of play.
- (v) No substitute is permitted and the player's position is left vacant for the remainder of the match, unless the player is the Centre. In this case one player must move to play as Centre and the position of this player is left vacant for the remainder of the match.



13. GAME MANAGEMENT

13.2 FOUL PLAY

Foul play is anything a player does within the field of play that is contrary to the letter and spirit of the Rules of the Game or does not meet accepted standards of good sportsmanship. It includes unfair play, dangerous play and misconduct.

13.2.1 Unfair Play

A player must not play unfairly. This includes delaying play, intentional infringing (including when the ball is not in play), persistent infringing, intimidation or retaliation.

(i) Delaying play

A player may not intentionally waste time or delay play.

Sanction: Penalty pass which is advanced (unless the non-infringing team is disadvantaged) and the player is cautioned.

- 1. The sanction may be advanced up to half a third (this may be to inside the goal circle if the infringement is in the goal third).*
- 2. The infringer stands out of play at the new position. If this is in an offside area the infringer moves to the edge of this area.*

(ii) Intentional infringing

A player must not intentionally infringe any rules.

Sanction: Penalty pass and the player is cautioned. If the player continues to infringe either a warning will be given or, if considered appropriate, the umpire will suspend the player.

(iii) Persistent infringing

A player must not persist in repeatedly infringing a rule or combination of rules.

13. GAME MANAGEMENT

Sanction: Penalty pass and the player is cautioned. If the player continues to infringe either a warning will be given or, if considered appropriate, the umpire will suspend the player.

(iv) Intimidation

A player, either with or without the ball, may not intimidate an opponent by using intentional behaviour (including verbal comments) designed to distract.

Sanction: Penalty pass and the player is cautioned.

(v) Retaliation

A player must not retaliate even if an opponent infringes the Rules.

Sanction: Penalty pass and the player is cautioned. If the action is considered to be serious the player is given a warning or suspended.

13.2.2 Dangerous Play

A player must not take any action, either reckless or dangerous that could affect the safety of another player. Such actions may include but are not limited to:

- (i) Punching, kicking, tripping or striking a player with any part of the body.
- (ii) Causing a player in the air to fall by moving into the path of that player.

Sanction: Penalty pass and the player is either warned, suspended or in a serious case ordered off.

13. GAME MANAGEMENT

13.2.3 Misconduct

Misconduct is any behaviour that is contrary to accepted standards of good sportsmanship.

(i) Dissent with an umpire

A player may not dispute a ruling given by an umpire or direct any offensive, insulting or abusive language and/or gestures at an umpire. If an umpire's call is not clearly heard a player may ask the umpire to repeat the infringement penalised or seek clarification of where a sanction is to be taken.

Sanction: Penalty pass and the player is either cautioned or given a warning. In a serious case the umpire will suspend the player.

(ii) Actions contrary to good sportsmanship

A player must not act in a manner contrary to accepted standards of good sportsmanship.

Sanction: Penalty pass and the player is either given a warning or suspended. In a serious case the umpire will order the player off.

13.3 DISCIPLINE OF TEAM OFFICIALS AND BENCH PLAYERS

During play team officials and bench players must remain at the team bench, except that bench players may leave the team bench for a valid reason (such as to warm up).

(i) During a match team officials and bench players may not:

- (a) Criticise the umpires or their decisions.
- (b) Use offensive, insulting or abusive language and/or gestures.
- (c) Use excessive noise or interruption.
- (d) Encourage foul play by on-court players.



13. GAME MANAGEMENT

Sanction: Penalty pass to the non-infringing team taken where the ball was when play was stopped. If the ball was out of court the penalty pass is taken on court in line with where the ball was out of court. No player is required to stand out of play for the penalty pass.

- (ii) Either umpire may hold time and notify the person/s concerned regarding such behaviour.

The following progression of actions will normally be used:

- (a) Caution.
 - (b) Warning.
 - (c) Order the person's removal from the playing enclosure.
- (ii) A warning may, if appropriate, be advised as applying to all team officials and bench players of the team concerned.

Sanction: Penalty pass to the non-infringing team taken where the ball was when play was stopped. If the ball was out of court the penalty pass is taken on court in line with where the ball was out of court. No player is required to stand out of play for the penalty pass.

- (iii) In the event that team officials or bench players do not respond to the umpire actions, the umpire requests the event organiser to remove them from the playing enclosure for the remainder of the match (including any contact with the team during intervals).

These match guidelines are to be used in conjunction with the INF Rules of Netball (2020 edition).

Officials should also be familiar with any event regulations for the competition and the INF Technical Officials Manual where this applies to interaction with the umpires.

RULE 3. TECHNICAL SPECIFICATIONS

- (i) [Rules 3.1 – 3.3]. The event organiser prepares the playing enclosure, the goalposts and ball to the specifications stated.
- (ii) Before a match starts the umpires:
 - (a) [Rule 3]. Inspect the playing enclosure, goalposts and match balls to check they conform to the Rules and provide a safe environment for play.
 - (b) [Rule 3.2]. These checks should include nets and pole padding (which should extend the **full length** of the pole).
- (iii) [Rule 3.3]. The event organiser provides at least two balls. These must meet all the specifications stated and be in a good condition.
 - (a) The umpires select the match ball and a spare ball to be held at the official bench.
 - (b) The same ball is used throughout the match unless the umpires instruct that it is replaced.
 - (c) Time will be held for blood on the ball, to allow it to be cleaned or replaced. In all other situations time should not be held for the ball to be wiped, instead it should be replaced.

RULE 4. MATCH DURATION

- (i) Before a match the umpires check with the event organiser:
 - (a) [Rule 4.1 (i)]. The length of the half-time interval.
 - (b) [Rule 4.2]. Whether extra time will be played if scores are tied at full-time, including the length of each half.
- (ii) During an interval the umpires may leave the playing enclosure. If both umpires leave, the reserve umpire remains there to check no changes occur to the field of play that could necessitate a further inspection.

RULE 5. MATCH PERSONNEL

- (i) [Rule 5.1.1 (iv)]. Prior to the match the umpires check the players in their respective changing rooms to ensure they meet all requirements.
 - (a) It is recommended that both umpires are together to carry out the check of each team.
 - (b) Umpires should remind players to check they are not wearing any adornments or jewellery before carrying out the inspection.
 - (c) Umpires should be satisfied that hair is suitably tied back so as not to provide a hazard or distraction for other players on the court.
- (ii) [Rule 5.1.1 (v) (a)]. The captains toss for choice of first centre pass or goal end. The toss is conducted on the field of play and must be observed by the reserve umpire. The two captains notify the scorers and the umpires of the result of the toss.
- (iii) [Rule 5.2.1 (i)]. After the captains have tossed, the umpires toss for goal end:
 - (a) The umpire's toss is observed by the reserve umpire.
 - (b) A member of either team may request to be present to observe the umpire's toss.

APPENDIX A: MATCH GUIDELINES

- (iv) Before play commences the umpires:
- (a) [Rule 5.1.1 (i)]. Check the players meet the requirements for play and the teams can be easily distinguished on the court. If necessary the teams will be required to wear bibs that distinguish them more easily or, if available, an alternative uniform.
 - (b) [Rule 5.1.1 (v) (d)]. Identify who the on-court captain is for each team. If the captain leaves the court during the match the umpires ensure they are advised which player is the replacement captain.
 - (c) [Rule 5.1.2 (ii) (b)]. Confirm the primary care persons are wearing appropriate identification.
 - (d) Check the team bench has a maximum of 12 players and up to 5 team officials. No other person/s are permitted to sit on the team bench.
Note: *If an accredited team doctor is present they must sit behind the team bench or in the opposite 'zone' with the media and other technical officials. Medical emergencies may occur at any time and common sense must apply as these emergencies will demand medical assistance as quickly as possible.*
 - (e) [Rules 5.3.1 and 5.3.2]. Ensure scorers and timekeepers are ready to commence their duties.
- (v) [Rule 5.2.1 (ii)]. An umpire's whistle starts and stops play as follows:
- (a) To instruct the timekeeper to commence timing at the beginning of a period of play or to restart play after a stoppage; a long whistle with umpire hand signal 1 [Appendix B].
 - (b) During play for an infringement, a toss up, to restart play after a goal or, when needed, to indicate the ball is out of court; a medium whistle with the relevant umpire hand signal [Appendix B].

- (c) To instruct the timekeeper to hold time; a medium whistle roll with umpire hand signal 2 [Appendix B].
 - (d) To end a period of play; a long whistle roll.
- (vi) [Rule 5.1 (ii)]. During a match:
- (a) If a team has less than 5 players available to take the court the umpire will blow the whistle to end play and award the match to the opposing team.
 - (b) If a team has more than 7 players on the court, the umpire will hold time and instruct the additional players to leave the court immediately. If players delay leaving the court the umpire will penalise the infringing player/s for delaying play [Rule 13.2.1 (i)].
- (vii) [Rule 5.2.2(i)] The reserve umpire should be ready to take the court quickly if required to replace an umpire who is injured or ill. Before taking the court the reserve umpire must ensure that they are aware of any cautions, warnings, suspensions or ordering off that have already been given by the umpires and the reasons for their action.
- (viii) [Rule 6.1.2 (i) (a)]. When penalising an infringement:
- (a) The umpire states the infringement and the sanction together with the appropriate umpire hand signal [Appendix B]. In a very fast moving match, due to the speed of play, experienced umpires may just state the infringement together with the appropriate umpire hand signal. [Appendix B].
 - (b) The umpire indicates where the sanction is to be taken. While reasonable flexibility may be used through the court it is important the position is clearly indicated in the goal circle or when it involves different court areas.

RULE 6. MATCH PROCEDURES

- (i) Before the start of a match and at the end of a period of play, both umpires check with the scorer which team has the next centre pass.
- (ii) [Rule 6.1.1 (iv)]. Throughout a match both umpires indicate the team to take a centre pass with umpire hand signal 3 [Appendix B]:
 - (a) [Rule 6.1.1 (iv) (a)]. If the umpires disagree the umpire nearer the official bench checks the centre pass with the scorer and time may be held while a check is made.
 - (b) [Rule 6.1.1 (iv) (b)]. Before the match starts the event organiser advises the means of notification by the scorer. If both umpires indicate the centre pass incorrectly, the scorer notifies them so a check can be made and notification **must be made before the centre pass has been taken**. An audible sound should be used for this purpose with umpire alerts used to cover any possible malfunction of that audible sound.
 - (c) If time is held immediately after a goal has been scored, the scorer will indicate the direction of the centre pass to restart play.
 - (d) The umpires may request a 'centre pass check' from the scorer as required.
- (iii) When the ball goes out of court the umpire controlling the side line or goal line indicates the direction of the team to take the throw in with umpire hand signal 3 or 4 [Appendix B].
- (iv) For any stoppage:
 - (a) Either umpire may hold time as appropriate. If a player is shooting for goal the shot may be completed before play is held, unless circumstances require time to be held urgently.



APPENDIX A: MATCH GUIDELINES

- (b) During a stoppage, both umpires remain on their respective side lines unless the situation requires a different course of action.
- (v) At the end of each period of play:
 - (a) [Rule 5.3.2 (iii)]. The timekeeper advises both umpires simultaneously when the specified time is reached. An electronic signal (siren) should be used by the timekeeper, with umpire alerts or a hand-held air horn used to cover any possible malfunction of that siren.
 - (b) [Rules 4.1 (iii) & 7.1.3 (iii)]. The controlling umpire immediately ends play. If play is to be extended for a penalty pass to be taken, the umpire will advise the players that time is being extended for the sanction to be taken.
 - (c) In the event the controlling umpire is unaware play should end, the co-umpire will signal the end of play. If play is to be extended for a penalty pass to be taken, the controlling umpire will advise the players that time is being extended for the penalty pass to be taken.

RULE 7. SANCTIONS

- (i) [Rule 7.1.3 (i)]. When a penalty pass is awarded, the sanction is 'set' when the player taking the penalty pass is positioned correctly with the ball and the infringer is also positioned correctly. 3 seconds is measured from the time **both** players are in position.

RULE 8. CONTROLLING PLAY

- (i) Warning whistles are given prior to the start of play:
 - (a) 30 seconds before play, a medium whistle roll.
 - (b) 10 seconds before play, a long whistle roll.
- (ii) At the start of each period of play, the umpire crossing the court takes the ball to the centre of the court before moving to the side line.

RULE 9. DURING PLAY

- (i) [Rule 9.2]. If a late player takes the court at an incorrect time, the player is sent from the court and the infringing team decides who should stand out of play for the penalty pass.
- (ii) [Rule 9.3.1]. Injury/illness or blood:
 - (a) If an on court player requests time to be held the umpire asks 'why?' If the reason relates to injury/ illness or blood, time is held. The umpire points to the player for whom play has been stopped and calls the playing position. The bench-side umpire advises the timekeeper of the reason and the player involved.
 - (b) Primary care person/s **wearing the correct identification**, may come onto the court to assess the player's injury/illness and to assist the player from the court. The player leaves the court and play restarts within 30 seconds (the timekeeper warns the umpire when 10 seconds remain).
 - (c) If the injury/illness is such that the player cannot be moved safely from the court within 30 seconds the primary care person/s alert the nearer umpire and advise the action that is appropriate. The umpires also remain alert for the need to check if a delay appears likely. The umpire decides how long time is held but endeavours to restart play as soon as possible.

- (d) Either umpire holds time when blood is seen on a player, the ball or the court. If blood is on the player or the player's clothing, the player must leave the court within 30 seconds and may not return to the court until this has been cleaned or clothing replaced.
 - (e) Any other players from either team with blood on them or their clothing must leave the court within 30 seconds and may not return to the court until this has been cleaned or clothing replaced.
 - (f) For blood on the court, time is held until it has been cleaned.
 - (g) For blood on the ball, time is held until this has been cleaned or alternatively the ball may be replaced.
 - (h) During a stoppage for injury/illness or blood, team officials and bench players may move onto the court surround so players may receive coaching and/or hydration.
 - (i) When time is held for blood, injury or illness to a player, substitutes or team changes may be made by both teams at any time during the stoppage. Substitutes may not enter the court until time has been held. The player concerned must leave the court before play may recommence.
 - (j) All players not affected or being substituted must remain on the court.
- (iii) [Rule 9.3.2]. Other stoppages:
- (a) For all other stoppages, the decision to hold time and the length of the stoppage is at the discretion of the umpires and either umpire may act as appropriate.
 - (b) It is important that consistent standards are used when deciding whether to hold time or not when the ball leaves the field of play. Loss of playing time is equally important at any time during a match, not just in the final minutes of a closely contested match.

RULE 13. GAME MANAGEMENT

- (i) An umpire **must** act if Foul Play is observed and the Rules provide **clear consequences** for unfair play, dangerous play and misconduct. Umpires are expected to rule accurately as with any other infringement. They should not avoid making difficult decisions regardless of the time elapsed in a match or what the resulting consequences may be. While umpires are expected to set and maintain clear standards and tone throughout a match, **players are ultimately responsible for changing their own behaviour.**
- (ii) Umpires have a range of strategies to control a match before resorting to formal game management. These should be applied in a way that is not officious or arrogant. When used skilfully and with understanding, these strategies will assist in minimising infringements by ensuring players are aware of the standards required of them so they can adjust their play accordingly.

Strategies may include the following:

- Wise choice between use of whistle or use of advantage.
- Change in delivery.
- Informal advice.
- Holding time to speak to players.

It is expected that these strategies will be used appropriately as the match context requires.

Formal game management **must** be applied when Foul Play occurs [Rule 13.2].

(iii) **Wise choice between use of whistle or use of advantage**

At times it will be necessary for the umpire to use the whistle to penalise an infringement. At other times, the skilled application of advantage will ensure that the flow of the game is maintained without control being lost or the non-infringing team being disadvantaged. Getting the correct balance here relies on the umpire's judgement and expertise.

(iv) **Change in delivery**

When umpires feel they need to deliver a stronger message, this can be achieved in several ways including:

- (a) Change in whistle tone, volume or length.
- (b) Change in voice tone, volume or speed of delivery (calm but firm).
- (c) Tactical pause to gain the player's attention.
- (d) Firmly state playing position first, followed by the infringement and sanction.
- (e) Body language.
- (f) Eye contact with player.

(v) **Informal advice**

Umpires should have a range of phrases they can use to indicate to players they need to change their behaviour without the need to hold time. This applies to low-level incidents only.

Examples of effective, specific phrases that can be used to change player behaviour include: Stay onside, adjust your distance.

Examples of ineffective, non-specific phrases that are unlikely to change player behaviour and should be avoided include: Tidy up, no more.

(vi) **Holding time to speak to players**

Umpires may hold time to speak to on-court players about their behaviour or to request the Captain to speak to any on-court player whose behaviour is causing concern.

If the umpire requests the Captain to speak to their player/s, the umpires will allow the Captain sufficient time to speak to the player/s concerned and then restart play as soon as possible.

Holding time adds a degree of seriousness when there is a pattern of infringing by a team or when opposing players are testing the limits of fair play and good sportsmanship. Everyone, including the team officials and bench players, is made aware that the umpire considers it important enough to stop play.

1A Start/restart of play

Arm held high, angled towards goal end of team with pass

**1B Start/restart of play**

Arm held high, angled towards goal end of team with pass

**2 Hold time**

Facing timekeeper, one hand vertical and other horizontal to form 'T'



3 Direction of pass

*for centre pass,
sanction, throw in*
Arm outstretched to side
pointing to goal end of
team with pass

**4 Throw in - goal line**

*for attacking team
at its goal end*
Arm angled down,
pointing to base of
goalpost

**5 Toss up**

Hand, palm up, makes
upward flicking
movement



6 Advantage

Arm sweeps across
body towards goal end
of team with advantage



7 Goal Scored

Arm held vertically



8 Goal not scored

Arms below waist
move from side to
side across each
other



APPENDIX B: UMPIRE HAND SIGNALS

9 Footwork

Hands, palms down,
move vertically up
and down in
opposite directions

**10 Centre positioned
incorrectly**

Hand traces
horizontal circle

**11 Offside or breaking**

Hand traces small upward
arc in direction of player's
movement



12 Ball over a third or untouched centre pass

Hand traces medium upward arc in direction of ball

**13 Held ball**

Arm held vertically with 3 fingers displayed

**14 Short pass**

Hands, palms inward a short distance apart, one hand moves towards the other held stationary



15 Incorrect playing the ball

Hands, palms inward
a short distance apart,
twist from side to side
in parallel motion

**16 Obstruction of player
with ball**

Hands, palms inward,
held short distance
apart

**17 Obstruction of player
without ball**

Arms angled out from
body below waist



18 Intimidation

Hand traces small arc in front of face



19 Contact

Hand, palm facing down, taps opposite forearm



20 Caution

Elbow bent, arm angled across head, palm facing towards player



21 Warning

Arms crossed
above head



22 Suspension

Arm held vertically
with 2 fingers
displayed



23 Ordering off

Hand sweeps from
player towards
team bench





APPENDIX C: UMPIRE TERMINOLOGY

When penalising an infringement, umpires should use the correct terminology for the infringement including correct use of playing positions [Rule 5.1.1 (ii)] and court areas [Rule 3.1]. Following a clearly communicated ruling by the umpire [Rule 6.1.2 (i) (a)], players should be able to understand the infringement and change their behaviour. At international level, terminology used should be precise and succinct. For matches below international level, additional information may be required to ensure that players are aware of how they need to change their behaviour.

RULE	TERMINOLOGY TO BE USED
8.2 Centre pass	8.2.1 (i) positioned incorrectly 8.2.1 (ii) & (iii) breaking 8.2.2 (iii), (iv) & (v) untouched
8.4.1 Out of court	8.4.1 (c) held ball 8.4.1 (d) footwork In all other situations, use incorrect throw in
8.5 Toss up	8.5.2 (ii) moved early 8.5.2 (iii) interference with toss
9.4.1 Methods of playing the ball	9.4.1 (iii) and (vii) held ball 9.4.1 (iv) & (v) replayed ball 9.4.1 (vi) (a) kick 9.4.1 (vi) (b) fall on ball 9.4.1 (vi) (c) strike 9.4.1 (vi) (d) roll 9.4.1 (viii) playing the ball on the ground 9.4.1 (ix) using goalpost
9.6 Footwork	9.6.3 (i) drag In all other situations use footwork
10.2 Requirements for taking a shot	10.2 (i) (a) incorrect shot 10.2 (ii) interference with shot
12. Contact	12.1 & 12.2 contact 12.2.1 causing contact 12.2.2 inevitable contact 12.2.3 simultaneous contact
For all other infringements	Use the appropriate rule heading terminology

APPENDIX D: VARIATIONS FOR OTHER LEVELS OF PLAY

Variations to the Rules may be made for matches that are not for international play. The extent of these variations will depend on the level of competition. For elite level competitions it is likely that few changes will be made, while for matches at lower levels changes may be more extensive.

Decisions regarding variations will normally be made by the controlling authority for the competition. Any variations should maintain the integrity of the Game on the court and should not change the way it is played. The following are some examples of variations that might be used.

(i) **Teams**

- (a) Teams may be made up of players of the same gender or may be mixed.
- (b) Team officials may be fewer than specified and may therefore undertake several duties. However, primary care person/s must not be players and it is preferable that they do not hold any other role.

(ii) **Equipment**

- (a) Courts may be outdoors where different surface materials may be used.
- (b) While international play uses 3-ply balls, a lower grade of ball (2-ply) may be used at lower levels. 2-ply balls will usually have a lower inflation level of 62-69 kPa (9-10 psi). For matches played outdoors the ball will usually have a lower inflation level.

(iii) Time

- (a) Time may be played in halves rather than quarters and these may vary in length up to a maximum of 20 minutes.
- (b) Quarters may be of a shorter length.
- (c) Intervals may be of a shorter length.
- (d) Extra time requirements may be varied.

(iv) Match and Technical Officials

- (a) A reserve umpire may not always be appointed.
- (b) The number of technical officials may be fewer (at least one scorer and one timekeeper should be appointed).
- (c) Umpires may use more specific terms if required for clarification e.g. for 'penalty pass' the umpire may state 'penalty pass or shot'.

(v) Matches for Young Players

For primary school age children, who are just beginning to play Netball, it is likely more extensive modifications may be desirable to allow for differences in stature, strength and skill level. Thus a lower goalpost or a smaller ball may be used. A modified game with variations to the playing rules may be developed to meet the needs of such players.



NOT FOR REPRINT



NOT FOR REPRINT



NOT FOR REPRINT

Contact

INF Secretariat
Albion Wharf
19 Albion Street
Manchester
M1 5LN
England

T: +44 (0) 161 234 6515
F: +44 (0) 161 228 6516
E: inf@netball.org



www.netball.sport